

VOLVO
240
SERIES

VOLVO 242, 244, 245



How big should a car be?

A decade ago, Volvo's full-size sedans measured about three-feet shorter than American "full-size". Today, when definitions are changing, the basic size of a Volvo has not.

Volvo dimensioned its automobiles around people and meeting their needs for comfort, safety and convenience rather than to arbitrary sizes based on marketing schemes and fashion. So through the years, Volvo has been able to apply its efforts toward making better, safer,

longer-lasting cars, not just bigger or smaller ones.

The 1977 new car introductions have brought yet another set of "new" dimensions from Detroit. Not surprisingly, more and more domestic cars are finally becoming almost "Volvo size". But as you will see, sensible proportions were just a starting point for Volvo. The quality that you'll find in the new Volvo 240 models cannot be measured in mere feet or inches.



True quality, like beauty, has to be more than skin deep.

Any automobile is no better than its weakest component or feature. Each design element, system or part of a Volvo has been rigorously tested and evaluated in Volvo's research center staffed by some 1200 engineers and technicians, on its vast 1750 acre proving grounds and in actual service in world-wide markets from the arctic to the tropics.

Volvo is committed to this extensive development because it believes there can be no short cuts to quality. Nor are there any compromises for safety and durability. Volvo puts power disc brakes on all

four wheels, not just two, makes its bumpers from thick zirconium alloy instead of stamped steel and protects passengers with a "safety cage" that has proven capable of supporting the weight of six Volvos. Still, you might never see or be aware of all that goes into a Volvo because individual elements are so well integrated.

Fuel injected engine is mounted well back and at an angle for less drive shaft vibration and a lower tunnel in the passenger compartment.

No tools are required to remove and replace sealed-beam headlight elements thanks to an ingenious fastener system.

Wrap-around bumpers are rubber-mounted to protect fenders from damage due to minor side impacts.

Bumpers themselves are made of thick zirconium alloy—exceptionally strong and resistant to corrosion. They're backed by gas-filled impact absorbers.

Engine fan on a slip clutch operates only when needed for less noise and greater horsepower at high speeds.

Guard-plate under the front of the engine compartment keeps out road spray and cuts noise.

Lightweight, wide-base front suspension is close to the wheels to provide more effective spring and shock absorber action.

Glass in all windows is lightly tinted to reduce glare and radiant heat.

The roof is supported by six box-shaped pillars that provide exceptional strength yet little obstruction to vision. Horizontal field: better than 90% in all models.

150 watts flows through the electric circuit fused onto the surface of the rear window to clear ice or mist in minutes.

One-way valves in rear vents permit stale interior air to escape and eliminate the pressure build-up that normally occurs when the blower is operated with windows closed.

Splash-guards, front and rear, protect underbody panels from salt and gravel.

Outside rear-view mirrors employ special "interference optics" for reduced day or night reflections.

Two layers of insulation (one porous, one dense) cover front floor and firewall to keep out heat and noise.

Wide-based wheels are centered on lathe-turned hubs rather than relying on wheel studs alone for true running.

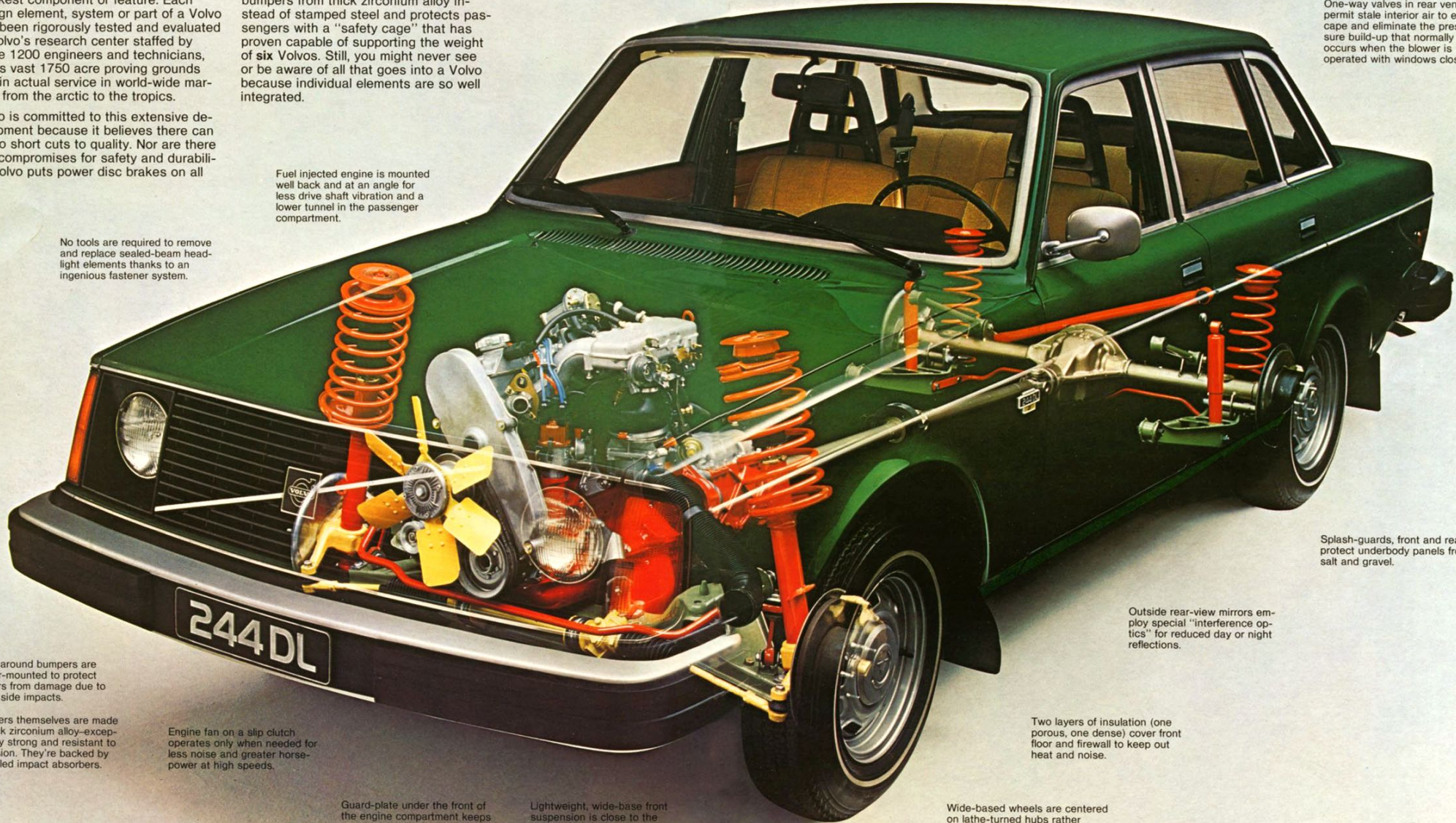

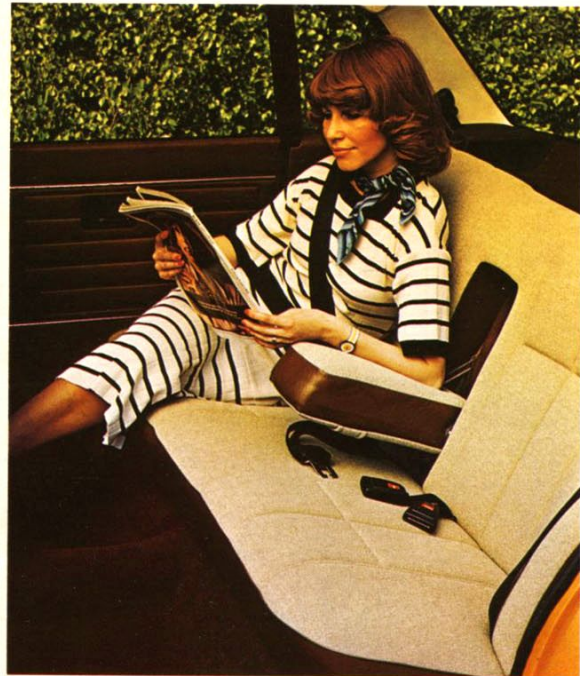

Volvo provides prescription comfort.

To millions of American drivers, it's obvious that forces on the human spine are actually greater when a person is seated than when standing. Volvo conducted and sponsored medical research has shown that firm lumbar (lower back) support, along with a reclined backrest can greatly reduce muscular strain and spinal pressure. The backrests of Volvo's individual front seats are fully reclining and incorporate a lumbar support mechanism that is adjustable for firmness. Both features are important to sustaining comfort, reducing driver fatigue and insuring a "custom fit". In all, Volvo front seats adjust **nine** ways, permitting them to satisfy the dimensional requirements of 97% of the U.S. adult population.

The rear seat of Volvo's 240 Series sedans is also designed for maximum comfort. Even in the 2-door version, rear seat entry is remarkably easy, thanks to Volvo's wide opening doors and generous knee and leg room. The edges of the rear seat back wrap around for lateral support and the broad seat base is constructed to provide comfortable, firm support for three adults with the central armrest folded.

To insure that seats retain their comfort, an elaborate network of steel wire and tempered coil springs are attached to a framework made of rigid steel profiles. Padding in the front seats consists of natural fibers, sprayed with rubber and covered by a layer of foam which is **sewn** into the upholstery. The soft, soil-resisting fabric used in the 240 sedans breathes, making it an ideal covering for winter or summer.

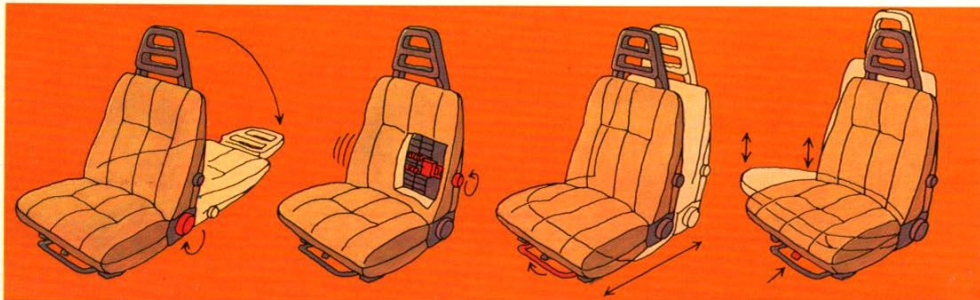

The highway offers enough distractions.

You won't find filigreed knobs or busy false wood appliques in the interior of a 240 Series Volvo. You will find controls that are ergonomically designed and placed—even the size and angle of the steering wheel were determined by scientific study. There's also a 12-outlet flow-through heating and ventilation system to insure a continually fresh supply of air, because the average adult takes in seven quarts of air per minute. And, thanks to a luggage compartment with 13.8 cubic feet of usable space, there's little need for the interior to be a place for anything but people.

Along with essential gauges displayed in Volvo's safety-designed instrument panel is a comprehensive system of warning lights. Included is a bulb integrity sensor which will indicate the failure of a low beam headlight, tail or brake light. There are also individual lamps to signal brake system malfunctions, when the handbrake is applied, when overdrive is engaged (on cars so equipped) and when current is flowing to the 150 watt rear window defroster/defogger. So that your hands never have to be too far from Volvo's safety steering wheel, two stalks—one for high/low beam selection and turn signals, the other for wiper/washer operation—are located on the steering column.

The controls for Volvo's advanced thermostatically-governed heating and ventilation system are contained in the central console. Each control has a single function to distribute warm or fresh air through 12 outlets—including two under the front seats for the rear compartment and two nozzles aimed at the front side windows to help keep them moisture free. The same controls are used when air conditioning is dealer installed. The system is designed to accept Volvo air conditioning and will perform in the same manner as the "Combined Unit" of Volvo's 260 Series which is capable of providing de-humidified warm or cool air.

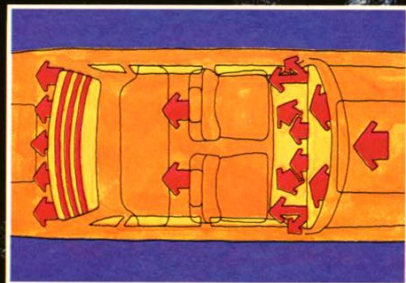

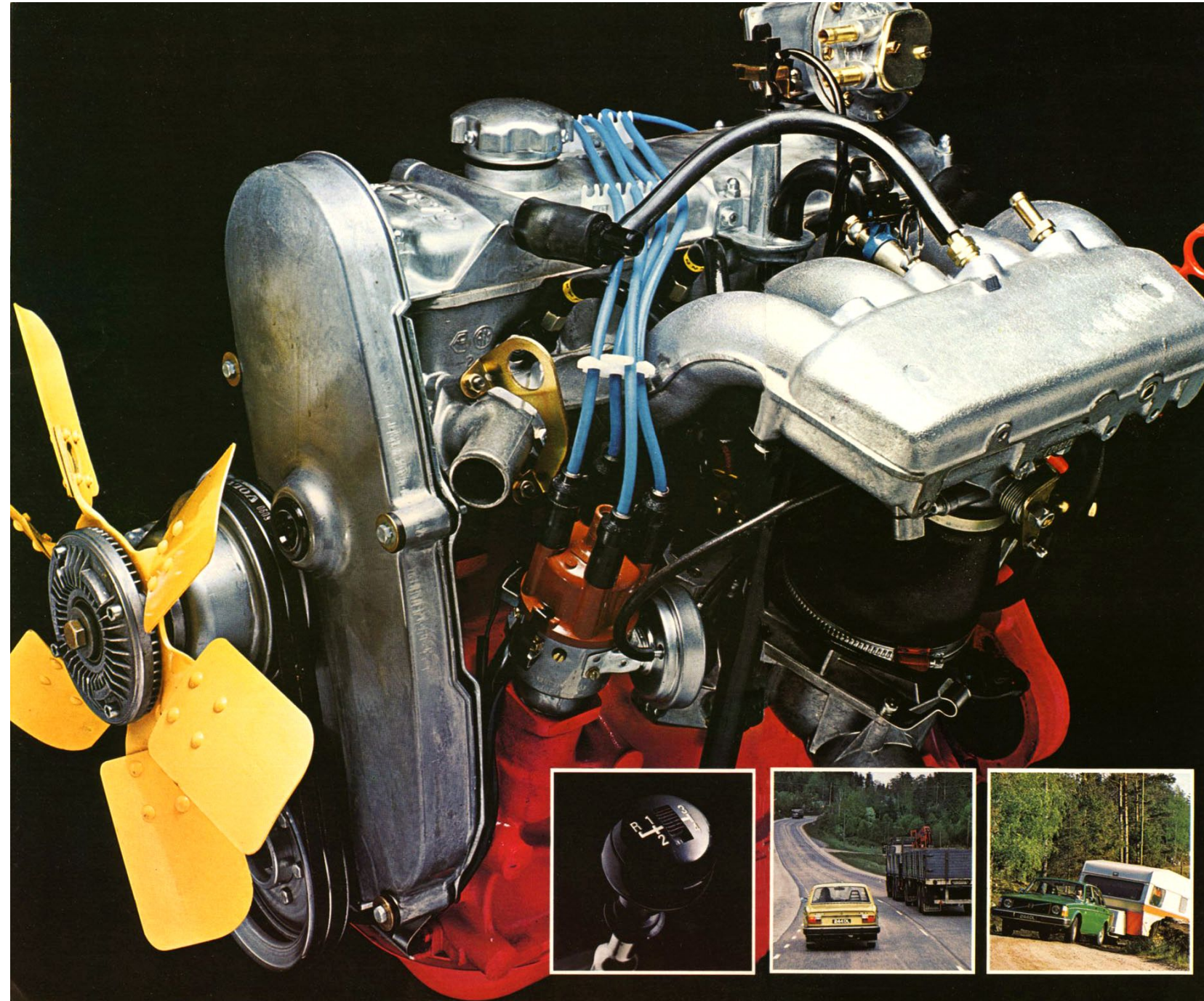

The 240 engine: an enlightened answer.

Demands for good performance matched with fuel economy have caught some car makers short. These qualities, along with lowered exhaust emission levels, are not easily achieved—particularly from engines that were designed to rely on sheer size, rather than efficiency, for performance.

In Europe, where fuel has long been expensive, and where years of speed-limitless driving developed keen appreciations for performance, relying on such expedients as displacement could mean extinction for auto-makers. Volvo is therefore well acquainted with demanding strictures and solutions—seven years ago it began equipping cars with fuel injection for improved performance and economy. The fuel injected, overhead cam engine of the 240 Series is specifically designed for today and the future, not a leftover from a previous era.

The 130 cubic inch (2.1-liter) B 21 F reflects advanced design and a very sporting character. It offers excellent low and mid-range torque for brisk acceleration and passing, plus effortless Interstate cruising capabilities and laudable economy.

Volvo's light-alloy "cross-flow" cylinder head yields performance benefits due to the design's free breathing characteristics. Another example of modern design is Volvo's belt-driven overhead camshaft. Push-rods and rocker arms have been eliminated meaning quieter running and fewer adjustments. Additionally, all Volvos are equipped with solid-state ignition systems for peak performance.

Like the sophisticated 260 Series V-6, all 240 models feature Volvo's "CI" fuel injection for reliable performance and economy under virtually any conditions.

To insure that this engine can deliver all its designed-in potential, Volvo offers specifically-matched transmissions. First, there's a precise, all-synchromesh four-speed manual which is also available with overdrive. The electrically-activated overdrive operates on fourth gear to reduce engine speed by 20% which can mean improved fuel economy in highway driving. There's also Volvo's versatile three-speed automatic which allows upshifts and downshifts to be selected automatically or manually—it can even be "kicked-down" into first for extra engine braking or quick acceleration.

Before you decide which is right for you, drive each version. One will suit your style and needs.

Volvos are fully equipped.

To complete the 240 Series, Volvo offers the practical 245—a Volvo with a carrying capacity rivaling bigger domestic station wagons. Understandably, the 245 is the best selling version of the popular 240

line, all of which are backed by a nationwide sales and service network of nearly 500 dealers.

Ask your dealer about Volvo's comprehensive warranty program and let him explain how you can drive a Volvo without owning one. Lease plans can be tailored to specific needs and can even include full maintenance coverage. After all, by looking at a Volvo you have proven yourself a considerate shopper and you should consider all the options.





The Volvo 245: long on space and convenience, but no longer than a Volvo sedan.

Further proof that "full-size" is a function of careful design and space utilization is provided by the Volvo station wagon. The 245 offers no less passenger space than a 244 sedan plus more than 42 cubic feet of luggage space—with the rear seat folded there's over 74 cubic feet of space. We've "opened up" a 245 to give you a better idea of what it can really handle. Remember the 245 is identical in length to a 240 sedan.

The 245 shares virtually all of the comfort features with Volvo's 240 sedans, including: thermostatically-controlled 12-outlet heating and ventilation system and Volvo's orthopedically-designed individually adjustable front seats, although durable vinyl is used exclusively as seat covering material in the 245. The full-width rear seat, which folds easily to permit a completely flat storage area, is also engineered for maximum comfort and support. Should you wish to increase the seating capacity of your 245 to seven, Volvo offers a rear-facing third seat. It too folds flatly into the cargo floor.

Access to the 245's spacious, flat-sided cargo area is facilitated by a full-width rear door. Hinged at the top it lifts easily aided by a gas cylinder mechanism. All rear doors have child-proof safety locks to help prevent accidental opening from the inside. To keep the rear window clear at all times it's electrically heated and has a wiper and washer.

The most impressive mechanical features of the 240 sedans are also found in the 245—it's powered by the same fuel injected "cross-flow" 2.1-liter Four, it's stopped by Volvo's four-wheel power disc brakes and the same manual and automatic transmissions are available.

Empty, the 245 weighs only slightly more than its sedan counterparts, so despite its big payload, there's little fuel economy penalty in normal day to day operation. Volvo engineers have also been able to maintain comparably high levels of ride and handling in the 245 with specially selected springs, shock absorbers and higher capacity steel-belted radial tires. The 245 is also easy to maneuver, its turning circle is the same as a 240 sedan, a tight 32 feet, 2 inches.

Balance: the key to fine ride and handling.

Ride and handling are two inter-related qualities, but like economy and performance in engine design, optimizing both is not an easy matter. That's because there's much more to a good ride than springs and shock absorbers, and more to handling than steering—the entire vehicle comes into play.

Suspension geometry, spring rates, shock absorber firmness, stabilizer bar diameters, steering ratio and the type and sizes of wheels and tires must be carefully matched to an automobile's other dimensions. Overall weight and its distribution, wheelbase and track, affect "balance"—the sort of balance that provides for a smooth, controlled ride and quick, responsive handling when you need it.

The only way to appreciate Volvo's fine balance is to compare it to what you're used to... on the road. But as background you might like to know some of Volvo's basic ride and handling ingredients.

Each front wheel is independently suspended by a coil spring/strut unit. Inside these rugged, compact units are double-acting shock absorbers. To control body lean in cornering with minimum sacrifice to ride when going straight over bumps, the front suspension is equipped with a stabilizer or sway bar. Volvo's rack and pinion steering is light, yet you'll never feel "disconnected" from the road, even with power assist (available with automatic transmission).

The rear suspension is also by coil springs and controlled by double-acting shock absorbers. Volvo's "live" rear axle is well-located by two support arms, two torque control rods, a track rod plus sedans are fitted with an additional stabilizer bar. To insulate against road shock, noise and vibration, rubber bushings are installed at strategic points throughout the suspension.

Fast responding rack and pinion steering is a compact unit with fewer parts than other systems. Power assist is standard with automatic transmission models and all Volvos have a tight turning circle of only 32' 2".

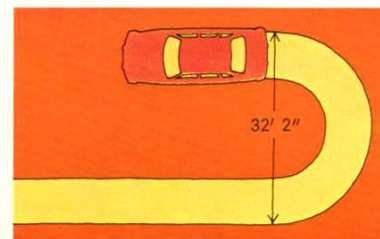

Safety: the toughest standards are Volvo's own.

Volvo is justifiably proud of its reputation for producing safe automobiles. Many of today's required safety features were introduced by Volvo long before they were mandated. In a number of cases, Volvo's designs even surpass the most stringent standards because of all the things that go into a Volvo, the most important ones are people.

As an industry leader in safety, research continues and fosters programs like Volvo's Experimental Safety Car. This project was conceived in 1972 and designed as a rolling test laboratory. The VESC was never intended for production, yet unlike many "experimental" cars, Volvo put not only the car, but lessons learned to good use.

The 1977 Volvo 240 Series incorporate a number of features that were influenced by the VESC project. Some of them include: new energy-absorbing front structure which, in combination with a very rigid center body section, adequately maintains passenger compartment integrity in barrier impacts at speeds to 50 mph... repositioned fuel tank... collapsing steering column... and attractive bumpers which completely absorb minor impacts.



Rigid members of the body form a protective cage around passengers. In addition to pillars and side-guard bars, the floor pan is reinforced by a large traverse box section. Special patterns stamped into the panels of the built-in "crumple zones" allow major impacts to be absorbed at controlled rates.

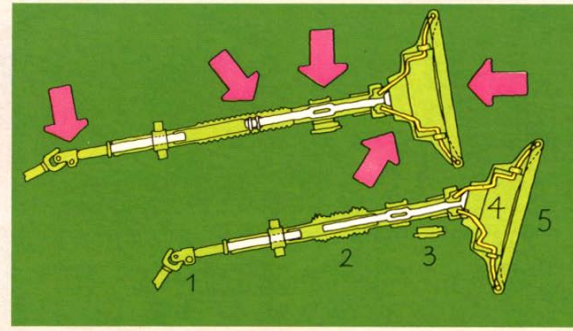

The Volvo steering column offers multiple stages of protection. First, the padded, deformable wheel. Second, the column is designed to collapse in stages. Finally, a universal joint in the lower section will fold like a pen-knife.

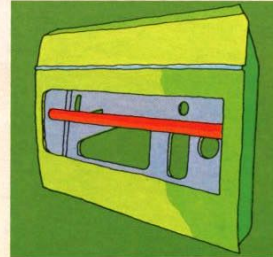
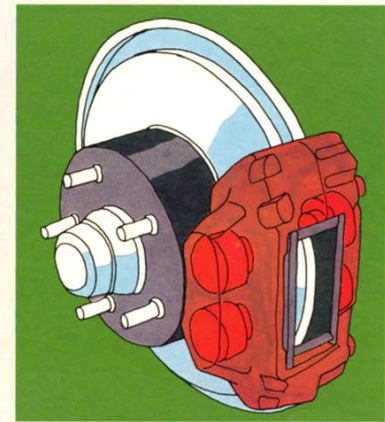

To protect occupants in the event of side impacts Volvo reinforces the doors of every car it makes with tubular profiles.

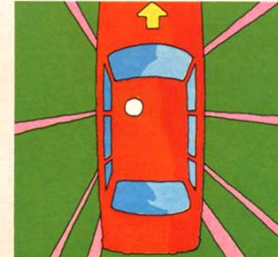

In all models, horizontal field of vision is better than 90%. The width of windshield pillars is less than the normal distance between your eyes, so you can see "around" them.

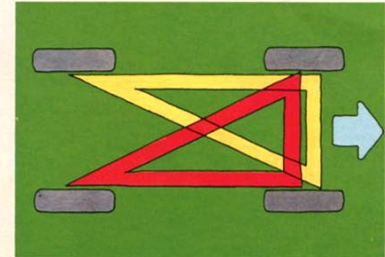

With Volvo's triangular-split safety braking system, both front wheels and one rear are served by two independent systems. Should one fail, about 80% braking effectiveness is still retained for safe, sure stopping.



The strength to endure.

In the years that the Swedish Motor Vehicle Inspection Company has collected data and compiled durability statistics, **Volvo** has **always** been the make with the longest life expectancy. The latest figures (1975) show the average life expectancy for a Volvo in Sweden to be 16.6 years!

Volvos are designed to last, but there's more to this legendary durability than long service and high trade-in value. Volvo's extensive efforts to keep its cars looking new also makes them safer. Rustproofing is not just a matter of preserving exterior surfaces, structural components that effect crash-worthiness and other safety aspects have received no less attention.

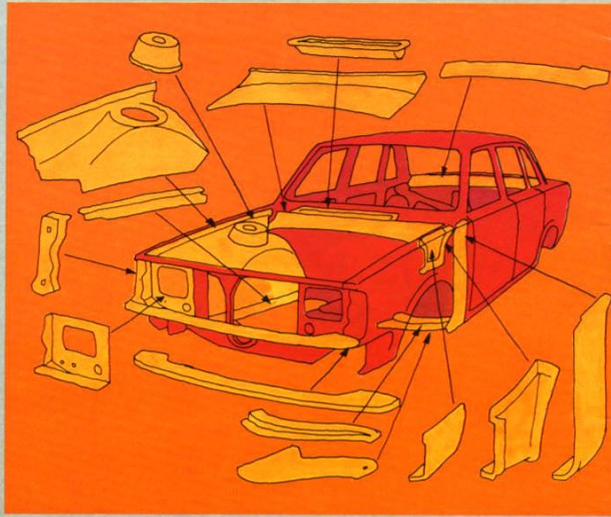

The use of hot-dipped galvanized sheet steel for areas most susceptible to rusting, including those to which safety related components are mounted, are shown in this drawing. Other examples of corrosion resistant materials are the aluminum alloy and stainless steel trim.

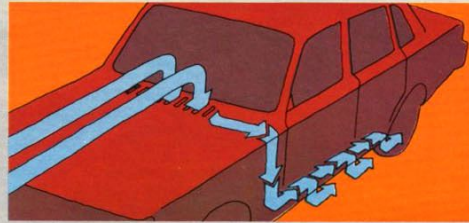

A Volvo body is not just painted, it is treated. The raw body is etched with phosphate, submersed in an electro-dip of primer and oven hardened. Then a filler coat is applied and joints are sealed with caulking compound before the top coats are sprayed. Rust prevention is

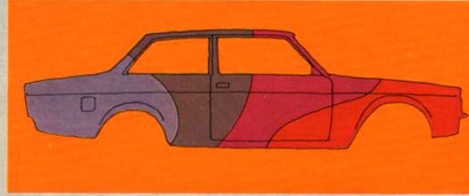

further enhanced by cavity-ventilation of the rocker panels and, on their outside, by a spray coating of polyester.



Underneath a Volvo is more evidence of Volvo's attention to durability and safety. A very rust-resistant, hardened copper/nickel based alloy is used for the brake lines. The rear muffler and other vulnerable parts of the exhaust system are made of aluminized sheet steel. In addition,

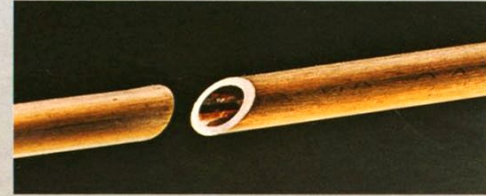

the underbody receives two separate rustproofing treatments and a rust-inhibiting agent is sprayed into all enclosed members.



Summary: 242, 244, 245.

Engine

Model B 21 F in-line four cylinder, cast iron block with five main bearings, aluminum-alloy "cross-flow" cylinder head. Valves actuated by a belt-driven, single overhead camshaft operating directly on bucket-type tappets. Induction by continuous-flow mechanical injection. Fuel is sprayed into each branch of aluminum inlet manifold. Type of fuel required: unleaded regular (91 RON).
B 21 F Lambda-Sond version, available in California and other markets, features a unique 3-way catalyst for lower emissions with excellent driveability and fuel economy. Included in the exhaust manifold is an oxygen sensor to regulate the air/fuel mixture. Displacement 130 cubic inches (2127 cc). Bore x Stroke 3.62 x 3.15 ins. (92 x 80 mm). Horsepower (SAE) 104 @ 5500 rpm, California 99 @ 5200 rpm. Torque (SAE) 114 ft. lbs. @ 2500 rpm. Compression ratio 8.5:1.

Fuel System

15.8 gallon tank with expansion chamber for evaporation control. Electric fuel pump.

Cooling System

Sealed "tropic" system holds 9.9 quarts of anti-freeze coolant. Fitted with a transparent expansion tank.

Electrical System

12-volt system features solid-state ignition without contact points, a 55A rated alternator and 60 amp hour battery. Starter motor output 1.1 hp.

Transmissions

Manual: Four-speed, fully-synchronized transmission has remote floor-mounted gear shift. Diaphragm spring clutch. Optional electrically-operated overdrive with a shift lever switch. Ratios: 1st 3.71:1, 2nd 2.16:1, 3rd 1.37:1, 4th 1.00:1. Overdrive 0.80:1. Final drive ratio 3.91:1.

Automatic: Optional three-speed automatic has a floor-mounted shift lever and an illuminated quadrant with a PRND21 pattern. Ratios: 1st 2.45:1, 2nd 1.45:1, 3rd 1.00:1. Final drive ratio 3.91:1.

Steering System

Rack-and-pinion type with a safety column. Power-assist standard on all models with automatic transmission. Ratio 17:1.1. Turns lock to lock 3.5. Turning circle 32'2".

Suspension

Front: Spring-strut type incorporating coil springs and telescopic shock absorbers. Stabilizer bar.

Rear: Rigid axle carried by longitudinal control arms and torque rods. Lateral location by track rod. Coil springs and telescopic shock absorbers, plus a stabilizer bar on sedans.

Wheels and Tires

Steel-belted white sidewall radial tires fitted on wide-offset 5.5" Jx14" pressed steel wheels. Tire size CR78-14, DR78-14 on 245.

Brake System

Self-adjusting disc brakes on all four wheels. Tandem type 4:1 power assist. Pressure relief valves on rear brakes. Dual hydraulic system, with stepped-bore master cylinder to maintain low pedal effort even if one circuit fails, connects both front wheels and one rear wheel on each circuit. Center handbrake operates mechanically on separate rear wheel drums.

Body

Unit construction with energy absorbing front and rear ends. Galvanized steel panels in rust susceptible areas. Two separate undercoats. Partly aluminized exhaust system.

Instrumentation and Operating Controls

Dashboard: Sealed speedometer with six-digit odometer and separate tripmeter. Fuel and coolant temperature gauges. Warning lights for alternator charging, oil pressure, high beams, overdrive, parking brake, foot brake failure, and to inform if a low beam, brake or tail light burns out. Audible and visible signals for turn indicators. Fully padded dashboard has four adjustable fresh air outlets and front door window demisting outlets. Quartz crystal clock. Illuminated, locking glove compartment.

Steering Column: Combined levers for high and low beam operation, turn and lane changing signals, windshield wipers and washer.

Center Console: Switches for the electrically-heated rear window, four-way hazard warning lamps and 245 rear window wiper and washer. Temperature and fan speed controls for the heating and optional air conditioning system. Cigarette lighter and ashtray. Radio location. Rheostat switch for instrument and controls lighting.

Heating and Ventilation System

Fully-integrated flow-thru system for fresh or heated air through 12 outlets to the windshield, front door windows, front and rear floors and along the dashboard. Two-stage, three-speed fan. Optional air conditioning uses the same outlets and fans and has recirculating and dehumidifying features. Sliding steel sunroof standard on sedans with overdrive transmission, also available with automatic transmission.

Seating

Orthopedic-designed reclining bucket seats with adjustable lumbar support in front, a bench seat with a folding armrest on sedans in the rear. Driver's seat has levers for front and rear height adjustment. Sedan upholstery is washable, stitched cloth, 245 seats covered with vinyl.

Other Standard Equipment

Three-point self-adjusting safety belts with illuminated center mount. Rear seat has two three-point belts and a lap belt. Rear seat lighting and ashtray. Tinted glass. Radio antenna built into windshield. Front stereo door speakers. Childproof rear door locks. Day/night position rearview mirror. Storage pockets in front doors. Towing points front and rear.

Accessories

Volvo has a wide variety of accessories, including stereo radios and tape players, designed to tailor-make a Volvo to your individual specifications.

Warranty and Maintenance

Volvo offers a 12-month limited warranty without mileage restriction. To help you fully understand your warranties, servicing needs and maintenance schedules, Volvo has prepared a descriptive booklet.

Leasing

Your dealer can advise you of the possible advantages of leasing and can budget a program to your specific needs. A variety of plans, including full-maintenance coverage, are available over 12-48 month periods.

Overseas Delivery

Volvo's comprehensive overseas delivery plan is designed so you can get the most out of your European vacation. All the details, even complete financing and our full-service home shipment package can be arranged in advance. See your Volvo dealer to develop a plan that accommodates your itinerary and schedule.

The factory reserves the right to make changes at any time, without notice, to prices, colors, materials, equipment, specifications and models and also to discontinue models.



VOLVO

RSP/PV 4027-77. USA. Printed in Germany

